



# OWNER'S MANUAL

## 715P

.22 CAL

SEMI-AUTOMATIC PISTOL

WITH DETACHABLE MAGAZINE

**IMPORTANT "SAFETY WARNINGS" – NOTE THE SYMBOL** 

**THESE SAFETY WARNINGS ARE FOR YOUR PROTECTION AS WELL AS THE SAFETY OF OTHERS. DISREGARDING INFORMATION IN THIS MANUAL MAY RESULT IN SERIOUS INJURY OR DEATH.**



Be certain this owner's manual is available for reference and is kept with this firearm if transferred to another party. If this manual is lost or misplaced, contact the Product Service Center for a free replacement copy.



After performing any work on your firearm such as cleaning, adjustments, disassembly or installation of any accessory, the firearm should be re-checked for proper functioning before firing live ammunition.



Firearms are complex mechanisms. Any modification, alteration, or improper fitting of parts may result in a dangerous malfunction, damage to the firearm and injury to the shooter and/or other persons. The firearm's owner must accept full responsibility for the correct reassembly and functioning of the firearm after any disassembly or replacement of parts.



If you do not understand any of the material in this manual or have any questions, contact the Product Service Center or a qualified gunsmith.



Do not attempt to load, handle or use the firearm until you read and understand the information contained in its owner's manual. Before handling your firearm, you should learn how it operates and how to maintain it. This includes knowing its basic parts, how the manual safety and other safety features operate, how to safely open and close the action and how to safely load and unload ammunition from the firearm. Improper use and handling is dangerous and could cause serious injury or death to you or those around you. All users of the firearm must become thoroughly familiar with the instructions in this manual.

---

distributed by

**MOSSBERG INTERNATIONAL, INC.**  
P.O. BOX 497 • 7 GRASSO AVENUE, NORTH HAVEN, CT 06473  
PHONE (800) 363-3555  
[www.mossberg.com](http://www.mossberg.com)

*Safety and safe firearms handling is everyone's responsibility.*



As the owner of a firearm, you must undertake the full-time responsibility of safe firearms handling for your own safety and the safety of those around you:

- Keep all firearms and ammunition out of the reach of children.
- Store your firearms and ammunition separately.
- Never store a loaded firearm.
- Never leave a loaded firearm unattended.
- Never transport a loaded firearm in a vehicle.
- Unload your firearm when you have stopped shooting and when you have to climb a tree, fence, cross a slippery surface or have to transport it in a vehicle.
- Do not load your firearm before you are in a place where it is safe to shoot, and keep your finger off the trigger until you are on target and have decided to fire.
- Never shoot at water, rocks or any hard surfaces. Bullets may glance off such surfaces and cause injuries.
- Do not use alcohol or drugs before or while handling firearms.
- Do not touch the trigger while the safety button is being engaged or disengaged.



Always point the muzzle of your firearm in a safe direction, regardless of whether the firearm is loaded or unloaded. You should become thoroughly familiar with the function and operation of this firearm and the instructions supplied with it.



Always treat every firearm as if it were loaded. Give your firearm to someone with the action open (bolt fully rearward), and the safety button pushed fully to the right to the "ON" (SAFE) position, after you verify the firearm is unloaded. Insist on the same procedure when receiving a firearm from someone else. Learn the location of all the safety features of your firearm and how they operate.



Wear eye and ear protection when shooting. Shooting without proper ear protection can cause hearing damage. The use of eye protection during any type of shooting is important to protect your vision.



When using a firearm with mounted optics, maintain an adequate distance between the rear of the scope and your face at all times. Be certain the scope installation does not interfere with access to, or the proper functioning of the safety button.



**We specifically disclaim any responsibility for damage or injury whatsoever occurring in connection with, or as a result of, the use of faulty, or non-SAAMI standard, or "remanufactured" or hand-loaded (reloaded) ammunition. Additionally, we disclaim any responsibility for damage or injury which results from any modifications or changes that are not a part of the firearm as delivered from the factory.**



Learn to clean your firearm thoroughly and make certain no oil, grease or other materials are blocking the barrel. Obstructions of any kind can cause damage to the firearm resulting in personal injury.

Practice proper firearm maintenance and safety. Make sure all exposed metal surfaces are coated with a thin film of oil, especially after being exposed to damp weather. (See proper section of this manual for cleaning instructions.) Do not plug the barrel or store in a fabric-lined case, which will absorb lubricants from the firearm. Before using after storage, follow complete instructions stated in this manual for refamiliarization with the firearm. A thorough inspection and function test should be performed before going into the field. Have your firearm periodically checked by a qualified gunsmith.

A note about the warnings and information contained in this manual:

We strongly suggest that you check with your local licensed retailer or state police for additional information concerning firearms ownership, or hunting or target shooting rules that may be required by local law or regulation. Since such rules and regulations are subject to change, local authorities are in the best position to advise you on such matters.

## TABLE OF CONTENTS

	Page
<b>General Information and Mechanical Characteristics</b> . . . . .	4
<b>Mechanical Safety</b> . . . . .	5
<b>Magazine Installation</b> . . . . .	6
<b>Keeping the Bolt in the “OPEN” Position</b> . . . . .	7
<b>Loading and Unloading the Magazine and Firearm</b> . . . . .	8
<b>Firing the Firearm</b> . . . . .	9-10
<b>Disassembly for Cleaning and Lubrication</b> . . . . .	10-13
<b>Cleaning and Lubrication</b> . . . . .	14
<b>To Re-assemble the Firearm</b> . . . . .	15-16
<b>Function Testing</b> . . . . .	16-17
<b>Precautions and Care with your Firearm</b> . . . . .	17
<b>Sight Adjustment</b> . . . . .	18
<b>Service Instructions</b> . . . . .	19
<b>Warranty Information</b> . . . . .	20
<b>Exploded View</b> . . . . .	21
<b>Parts List</b> . . . . .	21
<b>Notes</b> . . . . .	22-23
<b>Basic Rules of Safe Firearms Handling</b> . . . . .	Back Cover

## GENERAL INFORMATION AND MECHANICAL CHARACTERISTICS

The 715P is designed to operate with .22 long rifle cartridges of sub-sonic, standard, high or hyper velocities only.

When the firearm leaves the factory, its metal parts are protected by a coat of very adherent oil. This coating, especially inside of the barrel, must be removed before using the firearm. The oil on the outside surfaces should also be removed when the packing box has been open because the oil is very sticky and it easily retains dust and other solid impurities from the air.

The firearm is designed to fire semi-automatically. Finger pressure must be relieved from the trigger before an additional shot can be fired.



### WARNING

**Because this firearm can be used as a single shot, it will fire whether or not a magazine is in the firearm if a cartridge is chambered.**

**FIREARM WILL FIRE WITH MAGAZINE OUT.**

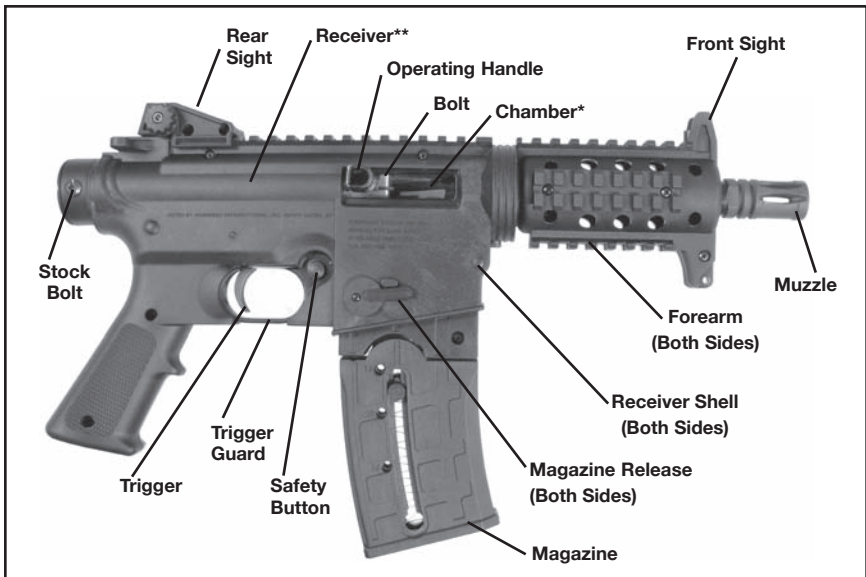

Fig. 1

\* The chamber is the rearmost part of the barrel. It can only be seen when the bolt is in the "open" position.

\*\* The receiver is enclosed in the receiver shells.



Read and understand this entire manual and its safety warnings before firing the firearm.

## MECHANICAL SAFETY

The safety button is located at the front of the trigger guard (Fig. 2) and must be manually moved to the desired position by the shooter. The safety mechanism cannot be engaged unless the hammer is cocked.



The safety is set in the “ON” (SAFE) position by pushing the button from the left side (side opposite the ejection port) so that it moves all the way to the right. The button must always be pushed fully to the right until it moves no further to be in the “ON” (SAFE) position.



Fig. 2



Remember, a firearm’s manual safety is a mechanical device which can never replace safe firearm handling practices.



Because any mechanical device can fail, never rely on any mechanism or safety device to prevent the dangers of careless handling or pointing a firearm in an unsafe direction.

Moving the safety button fully to the left will put the safety in the “OFF” (FIRE) position. The safety should be in the “ON” (SAFE) position until you are on target and have decided to fire.



The safety button is designed to function only as described above and should not be reversed. Do not attempt to remove or reverse the button. Doing so will result in an unsafe condition which can cause serious injury or death.

The safety button is marked with a red ring for training purposes as a reminder that moving it to the left with red showing is the “FIRE” position, moving it all the way to the right with red not showing is the “SAFE” position. The safety button can only be engaged when the hammer is cocked.

## MAGAZINE INSTALLATION

Familiarize yourself with the firearm by installing and removing an unloaded clip magazine and by learning to keep the bolt in the open position.



Ensure the safety button is fully to the right to the “ON” (SAFE) position and visually and physically check the chamber and the receiver area to be certain the firearm is unloaded.

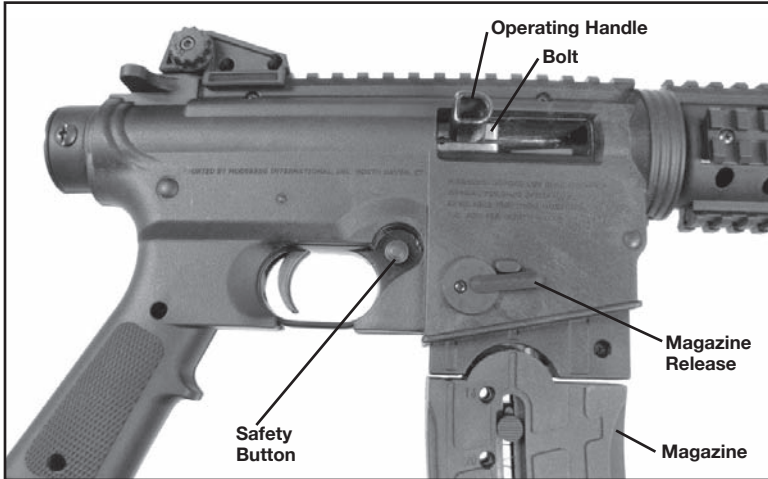

Fig. 3

### TO INSTALL CLIP MAGAZINE

Insert the unloaded clip magazine with the red cartridge follower end first and the long flat portion of the clip to the rear of the magazine opening. Push the magazine into place until it snaps into its locked position (Fig. 3). Be sure that the release lever is returned to its upmost position so that the magazine will snap into its locked position.

### TO REMOVE CLIP MAGAZINE

Press down on the magazine release on either side of the receiver shell and pull the magazine from the stock with your free hand. (Fig. 3)

**NOTE:** It is easier to install and remove the magazine from the firearm if the bolt is locked at its most rearward position by its operating handle. (Fig. 4 & 5)



### WARNING

**Removal of the magazine will not unload the firearm! Removing the magazine will not remove any cartridge which is in the firearm's chamber! A cartridge in the firearm's chamber can still be fired, even after the firearm's magazine has been removed! After you remove the magazine always visually and physically inspect the chamber and receiver to ensure the firearm is completely unloaded!**

**FIREARM WILL FIRE WITH MAGAZINE OUT.**

## KEEPING THE BOLT IN THE “OPEN” POSITION

If the magazine is not installed, pull the operating handle fully rearward then push the handle inward. To release the bolt, pull the end of the operating handle to the rear and outward to release.

If an empty magazine is installed, the magazine follower will keep the bolt in an open position. (Fig. 4) To remove the magazine, follow the instructions for your particular model in “To Remove Clip Magazine” section of this manual.



Fig. 4



Fig. 5

## TO LOAD AND UNLOAD MAGAZINE AND FIREARM

The magazine should be loaded before installing it to the firearm. Remove it from firearm as described in "To Remove Clip Magazine" section of this manual.

Load the magazine by inserting one cartridge at a time, pressing against the plastic follower and rearwards until it is fixed between the lips of the magazine. Repeat the operation until the magazine is full, or until the desired number of cartridges have been loaded. The magazine should be loaded with .22 Long Firearm cartridges only (Fig. 6). For best performance we recommend using Hi-Velocity ammunition.



Fig. 6



Before inserting the magazine into the firearm, point the muzzle in a safe direction, pull the operating handle fully rearward, release it, and let the bolt return to its most forward position. Move the safety button fully to the right to the "ON" (SAFE) position.

Insert the loaded magazine into the magazine opening until it snaps into its locked position.

Point the muzzle in a safe direction and ensure the safety button is still positioned fully to the right at the "ON" (SAFE) position. Using the operating handle, pull the bolt to its most rearward position, release it, and let the bolt return freely to its forward position. It may be necessary to pull out on the operating handle when it is in its most rearward position to get it to return to its forward position. The bolt will push one cartridge from the magazine into the chamber.

The firearm is now loaded.



Do not touch the trigger until you are on target and have decided to fire.



Removing the magazine does not unload the firearm! The firearm will fire if a cartridge is chambered, whether or not a magazine is in the firearm.



## FIRING



Discharging firearms in poorly ventilated areas, cleaning firearms, and/or handling ammunition may result in exposure to lead and/or other substances known to cause birth defects, reproductive harm, and other serious physical injury. Have adequate ventilation at all times. Wash hands thoroughly after exposure.

With the muzzle pointed in a safe direction and held in the proper firing position, move the safety button fully to the left to its “OFF” (FIRE) position. Pulling the trigger through its full travel to the rear, will fire the firearm. Ensure that the muzzle is pointed in a safe direction before placing your finger on the trigger.



Should any cartridge fail to fire, keep the muzzle pointed in a safe direction for at least thirty (30) seconds in case the cartridge is a “hangfire” (delayed firing of the cartridge after being struck by the firing pin). Then, remove the magazine (as it may still have loaded cartridges), pull the operating handle fully rearward and lock the bolt in the open position (Fig. 4 & 5) and extract and eject the misfired cartridge. Move the safety button fully to the right to the “ON” (SAFE) position. Segregate the misfired cartridge from other ammunition. Do not attempt to refire a misfired cartridge.



If at any time during firing, the sound of any cartridge is noticeably louder or softer than previous cartridges fired, STOP! Do not load or fire additional cartridges. Keep the muzzle pointed in a safe direction, remove the magazine (as it may still have loaded cartridges in it), and while keeping the ejection port and magazine well opening of the firearm turned away from your face (to protect your eyes in the event a defective cartridge explodes), pull the operating handle fully rearward and lock the action open. Visually and physically verify that the chamber is empty. Move the safety button fully to the right to the “ON” (SAFE) position. After unloading, inspect your firearm for possible damage or obstructions in the chamber or bore.

Upon firing, the pressure generated by the powder combustion will push the bolt to its rearward position, extracting and ejecting the fired cartridge case. Upon reaching its most rearward position, the bolt will have recoiled the hammer, and the bolt recoil spring will then push the bolt forward, feeding a new cartridge from the top of the clip magazine and chambering it. The firearm will again be ready to fire. This cycle will be repeated every time the trigger is pulled until there are no cartridges remaining in the magazine. If the trigger is pulled again, the firearm will then fire the live cartridge remaining in the firearm’s chamber. After this last cartridge has been fired, the clip magazine follower is designed to keep the bolt in the open position.

As the firearm was designed to fire semi-automatic only, it is mandatory to relieve pressure on the trigger after each shot in order to allow the disconnect to again connect the trigger to the firing mechanism.

After the last cartridge has been fired, the clip magazine follower is designed to keep the bolt in the open position. (Fig. 4)



Move the safety button fully to the right to the “ON” (SAFE) position and visually and physically inspect the chamber and magazine to ensure that there are no live cartridges present.

If the magazine is withdrawn from the firearm, the bolt will close; however, it is easier to remove the magazine from the firearm if the bolt is locked at its most rearward position by its operating handle.



Before inserting a new loaded magazine into the firearm move the safety button fully to the right to the “ON” (SAFE) position.

If the bolt is locked in its open position by the operating handle, to chamber a cartridge, insert a loaded magazine, pull the operating handle to the rear and outward and let the bolt move freely forward.



**The firearm is now loaded and will fire if the trigger is pressed.**

To interrupt shooting and unload the firearm, keep the muzzle pointed in a safe direction, move the safety button fully to the right to the “ON” (SAFE) position, remove the magazine and pull the bolt to its most rearward position, extracting and ejecting the cartridge in the chamber. Push the operating handle inward to hold the bolt open. (Fig. 4 & 5)

If desired or necessary, the firearm can be single loaded with a cartridge directly into the chamber. Pull the bolt rearwards and lock it to the receiver using the operating handle. Move the safety button fully to the right to the “ON” (SAFE) position and keeping the muzzle pointed in a safe direction, insert a cartridge directly into the chamber and close the bolt. It will be easier to single load the firearm if the magazine is removed from the firearm.



The firearm is now loaded and will fire when the trigger is pulled with the safety in the “OFF” (FIRE) position whether or not the magazine is in the firearm.

As a safety procedure, every time shooting is interrupted or the firearm is unloaded, move the safety button fully to the right to the “ON” (SAFE) position, and move the bolt to the open (rearward) position and locked open by pushing inward on the operating handle.

## DISASSEMBLY FOR CLEANING AND LUBRICATION



Remove the magazine. Pull the operating handle fully rearward to extract and eject any cartridge that might be in the chamber. Push the operating handle inward to lock the bolt in the open position. Move the safety button fully to the right to the “ON” (SAFE) position.



Visually and physically inspect the chamber and inside the receiver to be certain the firearm is unloaded. Wear eye protection during disassembly, cleaning, lubrication and reassembly to protect your eyes from oil spatter or spring loaded components.

Remove the rear sight by removing two #4 Plastite™ screws (Fig. 7).

Remove the stock bolt and end cap (Fig. 7).

Remove #2 Plastite™ screw and the right magazine release lever (Fig. 7). The left magazine release lever can now be removed (Fig. 8).

Remove the ten remaining #4 Plastite™ screws from the right forearm and receiver shells (Fig. 9). These can now be removed as a unit from the left half.

Using a 5/32" hex wrench, remove the front and rear takedown screws (Fig. 8). The action assembly can now be removed from the left shells.

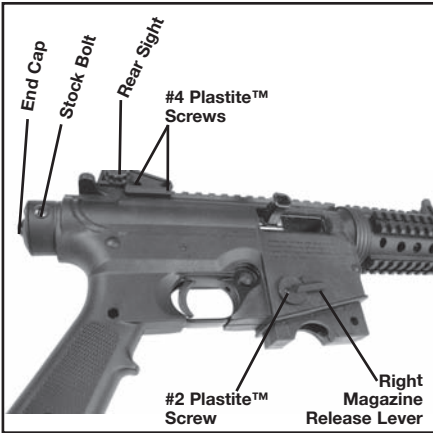

Fig. 7

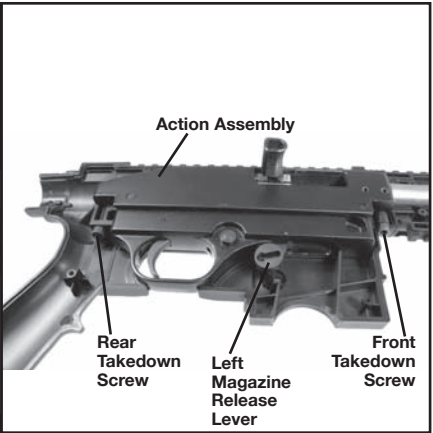

Fig. 8

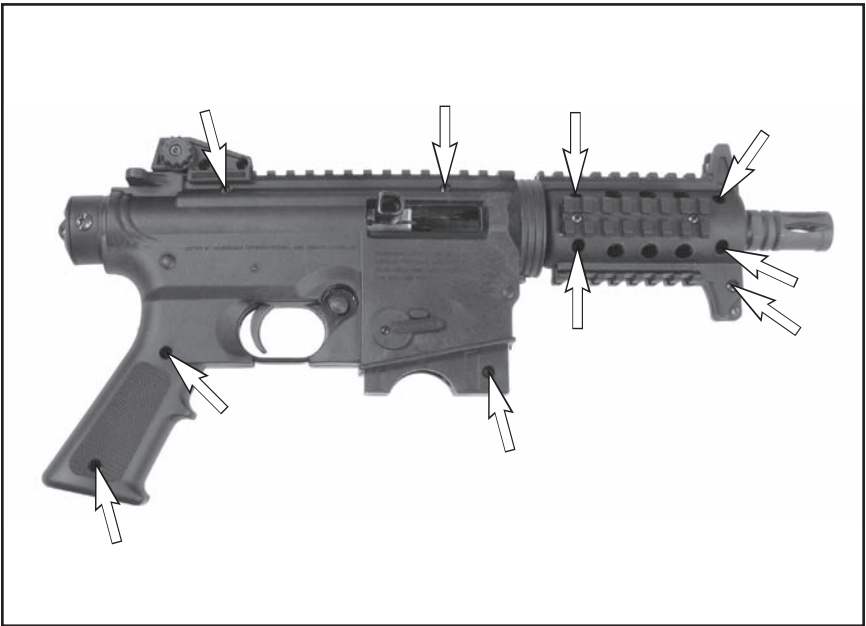
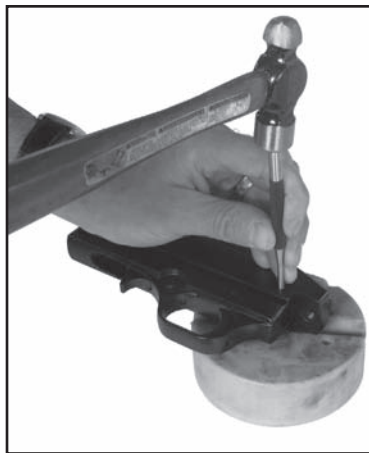

Fig. 9

## TO DISASSEMBLE THE FIREARM

With a pin punch or similar tool, remove the two trigger housing retaining pins located at the side of the receiver (Fig. 10). Be careful not to damage the black finish on the parts.



**Fig. 10**

While holding the operating handle fully rearward, carefully lift the trigger housing from the receiver (Fig. 11).



**Fig. 11**

Allow the operating handle to SLOWLY move fully forward. Remove the bolt buffer from the rear of the receiver (Fig. 12).

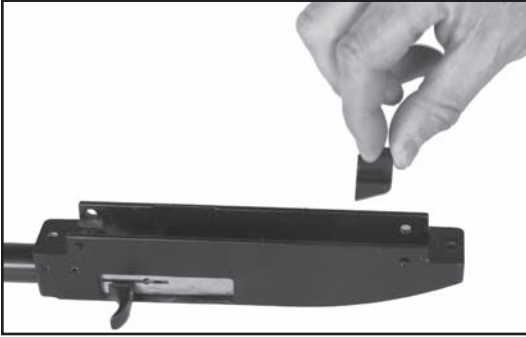

Fig. 12

Using the operating handle, pull the bolt rearward until you can insert your forefinger in front of the bolt. Be careful not to pinch your finger between the bolt face and the barrel. Lift up slightly on the bolt with your forefinger and remove the bolt handle through the ejection port.

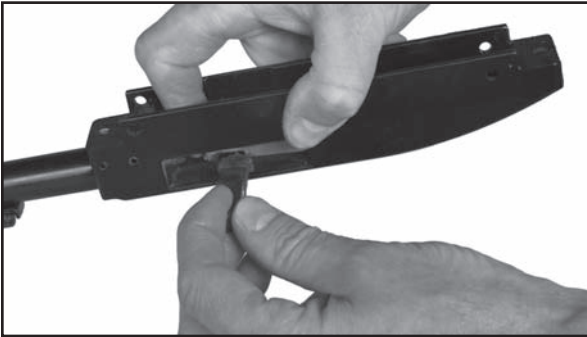

Fig. 13

Continue to lift up on the bolt while slowly letting it come forward to rest against the barrel. Reposition your forefinger grip and insert a finger through the ejection port (Fig. 14). Maneuver the bolt assembly completely up and out of the receiver. Remove the bolt spring and bolt spring guide rod (Fig. 15a).



Fig. 14

No further disassembly should be done by the owner. If service is required, contact the factory authorized service center or a qualified gunsmith.

## CLEANING AND LUBRICATION

**NOTE:** Semi-automatic firearms require more frequent cleaning than those manually operated.

With proper care, your Mossberg Int'l.™ pistol will provide you with years of dependable service. Your firearm should be inspected and cleaned after every 200 rounds to ensure that it remains in good condition. However, unusually dusty, dirty, or harsh weather conditions, or use of dirty ammunition which leaves significant powder residue may necessitate more frequent cleaning. Clean your firearm as soon as possible after use. This is especially important if your firearm has been exposed to moisture.

Follow the instructions and use the equipment provided in a quality firearm cleaning kit.

All metal parts should be cleaned with an appropriate firearm cleaning solvent and lightly lubricated with gun oil. Over lubrication should be avoided. Use only lubricants specifically designed for firearms. Avoid the use of abrasives, which may damage the metal finish.

Normal use requires only that the mechanisms be free of excessive shooting residue. Very little lubrication other than a light oiling of external surfaces is needed to prevent rust.

If the firearm is to be stored for a long period of time it should be thoroughly cleaned and oiled. Do not plug the barrel or store the firearm in a case that will absorb lubricants.

### THE TRIGGER HOUSING ASSEMBLY, BOLT ASSEMBLY AND RECEIVER

In the trigger housing, special attention should be given to the bolt sliding surfaces and to the feeding ramp. The bolt and the receiver must be carefully cleaned and free of any solid residues. Solid residues in the bolt/receiver areas may prevent the bolt from closing properly and a misfire may result.

### THE BARREL

Whenever possible, use cleaning products that allow cleaning the barrel from breach to muzzle. If this is not possible, be very careful while introducing the cleaning rod into the barrel muzzle, thus avoiding any damage to the barrel crown.

Use a .22 caliber brass cleaning brush, moistened with solvent, scrubbing the barrel several times.

Use a .22 caliber cleaning rod with a clean cloth patch to wipe the bore dry. Repeat several times, using a new patch each time, until the barrel is clean and shows no signs of residue.

Final wipe with a quality gun oil moistened patch. Do not over-lubricate, a light film is recommended.



Be sure not to leave cleaning patches or excessive oil or grease in the bore and make sure the barrel is free of obstructions and excessive lubricant after cleaning as they can create dangerous obstructions, resulting in damage to the firearm and/or serious personal injury to you or those around you.

## TO REASSEMBLE THE FIREARM

Assemble the bolt spring and bolt spring guide rod into the bolt assembly (Fig. 15a and 15b).

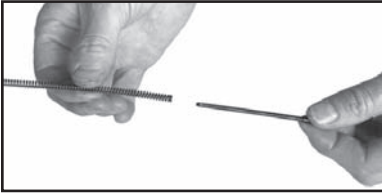

Fig. 15a

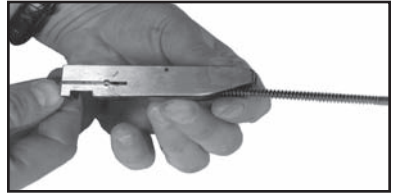

Fig. 15b.

Insert the assembly into the receiver, bolt face first (Fig. 16a). Insert the operating handle through the ejection port to line up with the operating handle slot in the bolt (Fig. 16a).



Fig. 16a



Fig. 16b

Compress the bolt spring and lower the bolt assembly into the receiver (Fig. 16b). As the bolt is lowered into the receiver make sure the operating handle does not move out of position. Compress the bolt recoil spring until the end of the bolt spring guide pops into the blind hole in the rear of the receiver.

Insert the bolt buffer (Fig. 17). Make sure it is oriented as shown in figure 12.

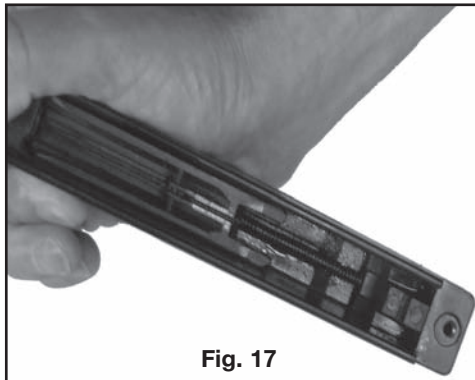

Fig. 17

Using the operating handle, push the bolt fully rearward. While holding the bolt fully rearward, place the trigger housing assembly into the receiver (Fig. 18). Allow the bolt to SLOWLY come fully forward. Align the holes in the trigger housing with the holes in the receiver, and insert the two trigger housing retaining pins (Fig. 10).



**Fig. 18**

Reverse the procedure outlined in the “Disassembly for Cleaning and Lubrication” section of this manual. Ensure that the front and rear takedown screws (Fig. 8) are securely tightened. Tighten the Plastite™ screws until snug. Do not over-tighten the Plastite™ screws as this can damage the forend and/or receiver shells.



Check to ensure the firearm is functioning properly, see “Function Testing” before using live ammunition.

## FUNCTION TESTING



**AFTER PERFORMING ANY WORK ON YOUR FIREARM SUCH AS CLEANING, DISASSEMBLY OR INSTALLATION OF AN ACCESSORY:**

- a. Keep the muzzle pointed in a safe direction, remove the magazine and pull the operating handle fully rearward to open the action, and visually and physically check the chamber and inside the receiver to be certain the firearm is unloaded.
- b. Move the safety button fully to the right to the “ON” (SAFE) position.



**KEEP THE MUZZLE POINTED IN A SAFE DIRECTION AT ALL TIMES THROUGHOUT THE FOLLOWING STEPS! FAILURE TO DO SO COULD RESULT IN SERIOUS INJURY OR DEATH IF THE FIREARM HAS NOT BEEN PROPERLY UNLOADED, AND FIRES WHILE YOU ARE TESTING ITS FUNCTION!**

Close the action and leave the safety in the “ON” (SAFE) position. Pull the trigger rearward fully. The hammer should not fall (No Fire).



Remove your finger from the trigger. Move the safety to the "OFF" (FIRE) position. The hammer should not fall (No Fire).  
Leave the safety in the "OFF" (FIRE) position.

Pull the trigger rearward. The hammer should fall (FIRE).

Open the action by pulling the operating handle fully rearward and push the operating handle in to lock the bolt in the open position. Move the safety button fully to the right to the "ON" (SAFE) position.



IF YOUR FIREARM DOES NOT PERFORM AS DESCRIBED IN ANY OF THE ABOVE STEPS, CONTACT THE PRODUCT SERVICE CENTER IMMEDIATELY. DO NOT ATTEMPT TO LOAD OR USE THE FIREARM.

## PRECAUTIONS AND CARE WITH YOUR FIREARM

When you store your firearm, make sure that the magazine and the chamber are empty.

Operation of the firearm and/or repeated disassembly may cause screws to loosen. Refer to the section of the manual TO REASSEMBLE THE FIREARM and check all screws including the Takedown Screws (Figure 8), the #4 Plastite™ Screws (Figure 9), the #2 Plastite™ Screw, and the Stock Bolt periodically and at each cleaning interval to ensure the continued accuracy and safe operation of your firearm. Care should be taken, especially with the #2 Plastite™ Screw that attaches the Magazine Release, not to over-tighten any screws as this may cause screws to strip.

Handling leaves moisture prints that can cause metal parts to rust. Abrupt changes in temperature cause condensation and moisture. Wipe the barrel and other metal parts with light oil after handling.

## SIGHT ADJUSTMENT

### BEFORE MAKING ANY SIGHT ADJUSTMENTS:

- a. Keep the muzzle pointed in a safe direction, remove the magazine and lock the operating handle in the open position (Fig 4 & 5), and visually and physically check the chamber and inside the receiver to be certain the firearm is unloaded.
- b. Move the safety button fully to the right to the "ON" (SAFE) position.

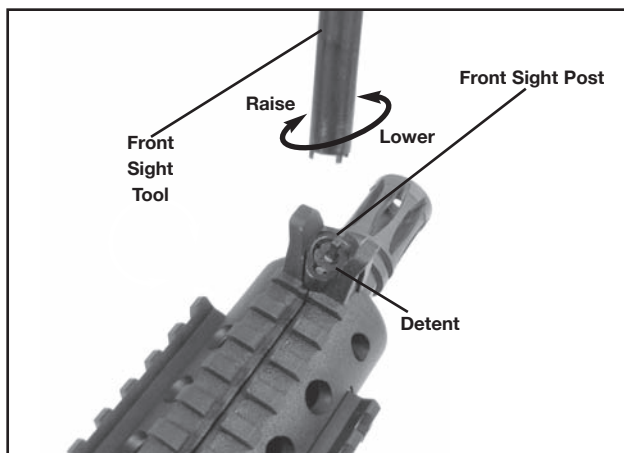

Fig. 19

**ELEVATION ADJUSTMENT:** To raise the point of impact, lower the front sight post by turning it clockwise. To lower the point of impact, raise the front sight post by turning it counter-clockwise. In order to turn the front sight post, the detent must first be depressed (Fig. 19). This can be accomplished by use of an AR front sight adjustment tool, or alternatively by holding down the detent with a small punch or other similar object.

**WINDAGE ADJUSTMENT:** To move the point of impact to the right, turn the windage adjustment screw clockwise. To shift the point of impact to the left, turn the windage adjustment screw counter-clockwise.

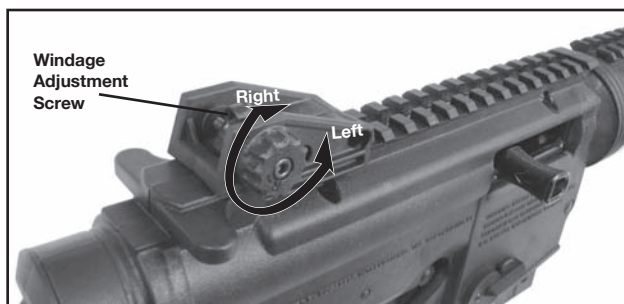

Fig. 20

## SERVICE INSTRUCTIONS

Should your firearm, or any component of your firearm require service, ship your entire firearm (please do not send components only), via your chosen carrier, postage paid (we do not accept C.O.D. shipments), following these instructions:



- Make absolutely certain your firearm is unloaded.
- Do not send ammunition with your firearm.
- Remove all accessories from your firearm such as scopes, slings, mounts, etc.
- Ship your firearm in a suitable container, packaging it securely to prevent parts from shifting and/or harm during shipping.
- Include a note with a clear description of the service you wish us to perform, your complete return shipping address (no P.O. boxes please), your daytime telephone number and your e-mail address (if available). It is advisable to place your correspondence inside your shipping container when shipping.

### SHIPPING ADDRESS

Product Service Center  
Maverick Arms, Inc.  
1001 Industrial Blvd.  
Eagle Pass, TX 78853  
Attention: Repair

### **IMPORTANT NOTICE:**

Pistols must be returned via  
UPS Next Day or Federal Express

If you have any questions, please contact the Product Service Center at (800) 363-3555, or [service@mossberg.com](mailto:service@mossberg.com)

### TO ORDER PARTS FROM US

To order parts from the Product Service Center, you can fax, phone, mail, or e-mail your order to us at one of the below numbers/addresses.

Fax Number: (830) 773-5893

Phone Number: (830) 773-9007

E-mail Address: [service@mossberg.com](mailto:service@mossberg.com)

Mailing Address: Product Service Center  
Maverick Arms, Inc.  
1001 Industrial Blvd.  
Eagle Pass, TX 78853  
Attention: Order Department

Please provide your name, address, city, state, zip, your daytime phone number and e-mail address. We'll need Model #, Serial #, Gauge/Caliber, Finish, Part # and Part Name. We have a \$7.50 (U.S.) minimum parts order charge. We accept most major credit cards, personal checks, money orders, and bank drafts.

Service outside of the U.S.A.

For Mossberg International firearm parts and service requirements outside of the United States, customers are requested to contact the closest Mossberg International stocking dealer/distributor.

MOSSBERG INTERNATIONAL WARRANTY  
715P .22 CALIBER SEMI-AUTOMATIC PISTOL  
ONE (1) YEAR LIMITED WARRANTY

Limited Warranty: Mossberg International, Inc. ("Mossberg") warrants to you, the original retail purchaser of a new Mossberg Int'l.<sup>TM</sup> .22-caliber semi-automatic pistol (the "Mossberg firearm"), that the Mossberg firearm will be free of defects in material or manufacture for a period of one (1) year from the date of your purchase of the new Mossberg firearm (the "Warranty Period") in the United States or Canada. This is the only express warranty on the Mossberg firearm.

MOSSBERG MAKES NO OTHER WARRANTIES OF ANY KIND OR CONDITIONS, INCLUDING, BUT NOT LIMITED TO ANY IMPLIED WARRANTY OF MERCHANTABILITY OR FITNESS FOR A PARTICULAR PURPOSE.

This Limited Warranty gives you specific legal rights, and you may have other rights that vary from State to State.

Purchaser's Remedy: During the Warranty Period, Mossberg will, at its sole option, (1) repair the Mossberg firearm or any part thereof that, upon examination and testing by Mossberg, does not conform to the Limited Warranty without charge to you for parts or labor, or (2) replace the Mossberg firearm with a new or similar model. THIS REMEDY SHALL BE YOUR EXCLUSIVE AND SOLE REMEDY FOR ANY BREACH OF WARRANTY. MOSSBERG SHALL NOT BE RESPONSIBLE FOR ANY OTHER EXPENSES, LOSSES OR INCONVENIENCE THAT YOU MAY SUSTAIN AS A RESULT OF THE PURCHASE, USE, MALFUNCTION OR DEFECTIVE CONDITION OF THE MOSSBERG FIREARM. Mossberg reserves the right to inspect, examine and/or test the Mossberg firearm to assess any claim made under the Limited Warranty.

EXCLUSIONS: THIS WARRANTY DOES NOT COVER THE COSMETIC APPEARANCE OF THE MOSSBERG FIREARM OR ANY DAMAGE CAUSED BY:

- (1) NORMAL WEAR AND TEAR;
- (2) FAILURE TO PERFORM PROPER CARE AND MAINTENANCE;
- (3) ACCIDENTS, ABUSE OR NEGLIGENCE;
- (4) BARREL OR BORE OBSTRUCTIONS;
- (5) FAILURE TO FOLLOW THE INSTRUCTIONS AND WARNINGS THAT ACCOMPANY THE MOSSBERG FIREARM; OR
- (6) THE USE OF DEFECTIVE, NON-SAAMI STANDARD, REMANUFACTURED, HAND-LOADED, AND/OR RELOADED AMMUNITION.

IN ADDITION, ANY UNAUTHORIZED REPAIRS, ALTERATIONS OR MODIFICATIONS TO THE MOSSBERG FIREARM WILL AUTOMATICALLY VOID THE LIMITED WARRANTY.

LIMITATION OF DAMAGES: EXCEPT WHERE PROHIBITED BY LAW, MOSSBERG WILL NOT BE LIABLE FOR ANY LOSS OR DAMAGE WHATSOEVER ARISING FROM THE USE OF THIS MOSSBERG FIREARM, WHETHER DIRECT, INDIRECT, SPECIAL, INCIDENTAL, CONSEQUENTIAL OR PUNITIVE, REGARDLESS OF THE LEGAL THEORY ASSERTED, INCLUDING CONTRACT, WARRANTY, NEGLIGENCE, OR STRICT LIABILITY. SOME JURISDICTIONS DO NOT ALLOW LIMITATIONS ON HOW LONG AN IMPLIED WARRANTY LASTS, OR THE EXCLUSION OF INCIDENTAL OR CONSEQUENTIAL DAMAGES, SO THE ABOVE LIMITATIONS MAY NOT APPLY TO YOU.

Warranty Service: To obtain service under this Limited Warranty, you must follow the instructions found in the "Service Instructions" section of the Owner's Manual and return the Mossberg firearm to the authorized Product Service Center. You are responsible for all shipping costs to the Product Service Center. Mossberg will not accept COD shipments of any Mossberg firearm for service. After repair or replacement, the Mossberg firearm or a similar model will be returned to you, return postage paid by Mossberg. If we replace the Mossberg firearm, we will keep the firearm that you returned to Mossberg.

Modification of Warranty: No agent, representative, distributor, or authorized dealer of Mossberg firearms has any authority to modify the terms or conditions of the Limited Warranty in any way. The Limited Warranty may only be modified in writing by an authorized officer of Mossberg.

**THIS LIMITED WARRANTY IS EFFECTIVE JANUARY 1, 2013.**

# EXPLODED VIEW

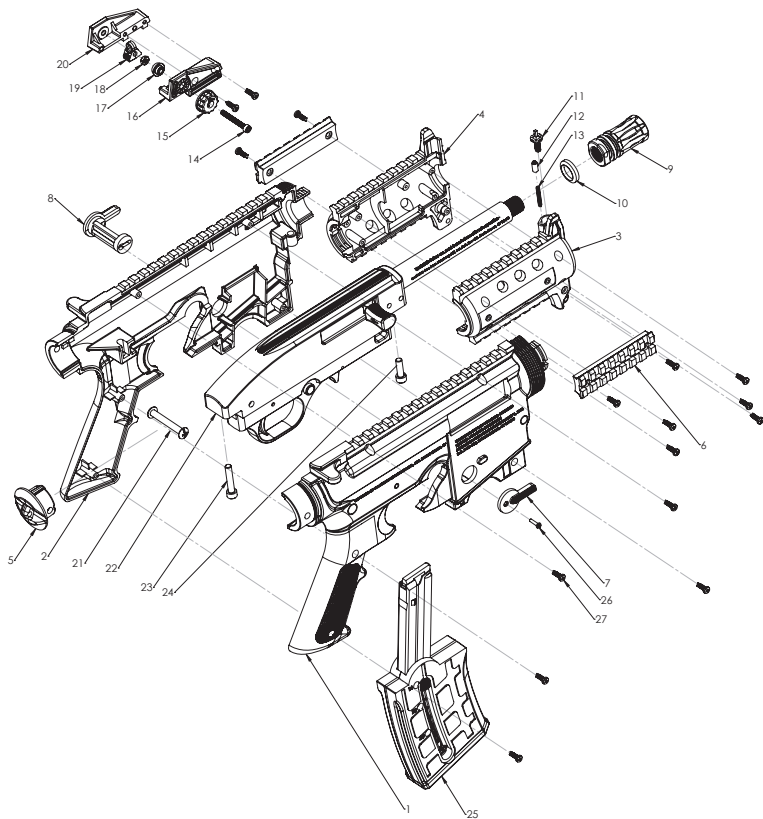

# PARTS LIST

<u>Item No.</u>	<u>Description</u>	<u>Item No.</u>	<u>Description</u>
1	Receiver Shell, Right	15	Windage Knob
2	Receiver Shell, Left	16	Rear Sight, Right
3	Forearm Shell, Right	17	Windage Bushing
4	Forearm Shell, Left	18	Windage Nut
5	Receiver Cap	19	Aperture
6	Accessory Rail (2 Pieces)	20	Rear Sight Left
7	Magazine Release Lever, Right	21	Stock Bolt (2 Pieces)
8	Magazine Release Lever, Left	22	*Receiver and Barrel Assembly
9	Muzzle Brake	23	Rear Take Down Screw
10	Crush Washer	24	Front Take Down Screw
11	Front Sight Post	25	Magazine Assembly
12	Front Sight Detent	26	#2 Plastite™ Screw
13	Front Sight Detent Spring	27	#4 Plastite™ Screw (16 Pieces)
14	Windage Screw		

Items marked with an asterisk (\*) are reserved for qualified gunsmiths only.

**NOTES**

A large, empty rectangular box with a thin black border, occupying most of the page. It is intended for the user to write their notes.

**NOTES**

A large empty rectangular box with a double-line border, intended for notes. The box is vertically oriented and occupies most of the page's width and height.

## **FIREARMS SAFETY DEPENDS ON YOU. MAKE NO MISTAKE ABOUT IT!**

From the time an individual picks up a firearm, that individual shooter becomes a part of a system over which he has complete control. He is the only part of the system that can make a gun safe – or unsafe. Hunting and target shooting are among the safest of all sports. This booklet is intended to make them even safer – by re-emphasizing and reaffirming the basics of safe gun handling and storage and by reminding each individual shooter that he or she is the key to firearms safety. You can help meet this responsibility by enrolling in hunter safety or shooting safety courses. You must constantly stress safety when handling firearms, especially to children and non-shooters. Newcomers in particular must be closely supervised when handling firearms with which they may not be acquainted. Don't be timid when it comes to gun safety. If you observe anyone violating any safety precautions, you have an obligation to suggest safer handling practices, such as those in this booklet. Please read these rules carefully and follow the safety procedures outlined. Firearms safety is up to you. Make no mistake about it.

- 1. ALWAYS KEEP THE MUZZLE POINTED IN A SAFE DIRECTION**
- 2. FIREARMS SHOULD BE UNLOADED WHEN NOT ACTUALLY IN USE**
- 3. DON'T RELY ON YOUR GUN'S "SAFETY"**
- 4. BE SURE OF YOUR TARGET AND WHAT'S BEYOND IT**
- 5. USE CORRECT AMMUNITION**
- 6. IF YOUR GUN FAILS TO FIRE WHEN THE TRIGGER IS PULLED, HANDLE WITH CARE**
- 7. ALWAYS WEAR EYE AND EAR PROTECTION WHEN SHOOTING**
- 8. BE SURE THE BARREL IS CLEAR OF OBSTRUCTIONS BEFORE SHOOTING**
- 9. DO NOT ALTER OR MODIFY YOUR GUN, AND HAVE GUNS SERVICED REGULARLY**
- 10. LEARN THE MECHANICAL AND HANDLING CHARACTERISTICS OF THE FIREARM YOU ARE USING**

*Courtesy of  
Sporting Arms and Ammunition Manufacturers' Institute, Inc.*